

3A Low Dropout Positive Regulators
PRODUCTION DATA SHEET
DESCRIPTION

The LX8385/85A/85B Series ICs are positive regulators designed to provide 3A output current. These regulators yield higher efficiency than currently available devices with all internal circuitry designed to operate down to a 1V input-to-output differential. In each of these products, the dropout voltage is fully specified as a function of load current. Dropout is guaranteed at a maximum of 1.3V (8385A/B) and 1.5V (8385) at maximum output current, decreasing at lower load currents.

In addition, on-chip trimming adjusts the reference voltage tolerance to 1% maximum at room temperature and 2% maximum over the 0 to 125°C range for the LX8385A. The LX8385B offers 0.8% tolerance at room temperature and 1.0% maximum over line, load and temperature. Fixed versions are also available and specified in the Available Options table below.

The LX8385/85A/85B Series devices are pin-compatible with earlier 3-terminal regulators, such as the 117 series products, but they do require input and output capacitors. A minimum 10 μ F capacitor is required on the input and a 15 μ F or greater on the output of these new devices for stability. Although, these capacitors are generally included in most regulator designs.

The LX8385/85A/85B Series quiescent current flows into the load, thereby increasing efficiency. This feature contrasts with PNP regulators where up to 10% of the output current is wasted as quiescent current.

The LX8385-xxI is specified over the industrial temperature range of -25°C to 125°C, while the LX8385-xxC / 85A-xxC / 85B-xxC is specified over the commercial range of 0°C to 125°C.

IMPORTANT: For the most current data, consult MICROSEMI's website: <http://www.microsemi.com>

KEY FEATURES

- Three-Terminal Adjustable Or Fixed Output
- Guaranteed 1% Voltage Reference Accuracy Over Line, Load, And Temperature (LX8385B)
- Guaranteed < 1.5V Headroom At 3A (LX8385)
- Guaranteed < 1.3V Headroom At 3A (LX8385A/8385B)
- 0.015% Line Regulation
- 0.15% Load Regulation

APPLICATIONS

- High Efficiency Linear Regulators
- Post Regulators For Switching Power Supplies
- Battery Chargers
- Constant Current Regulators
- Graphics & Standard Supplies
- Processor I/O Supply
- Low Voltage Memory & Chipset Supplies

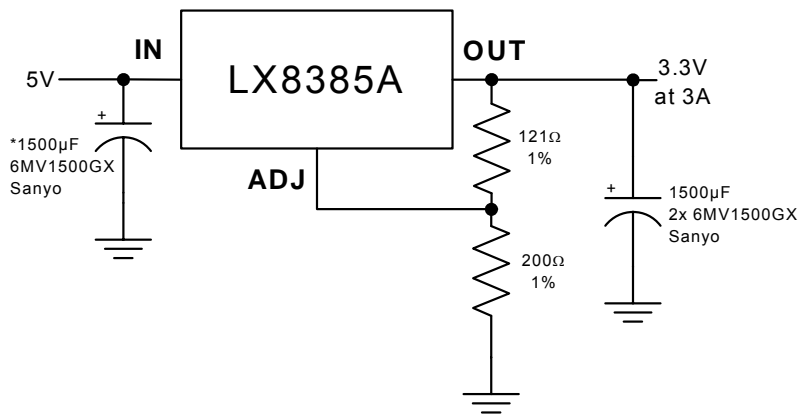
PRODUCT HIGHLIGHT

PART #	OUTPUT VOLTAGE
LX8385/85A/85B-00	Adjustable
LX8385/85A/85B-33	3.3V
LX8385/85A/85B-05	5.0V

Table 1 - Available Options

PACKAGE ORDER INFO

T _A (°C)	Max Ref Accuracy	Max Dropout Voltage	DT	P	DD
			Plastic TO-252 (D-Pak) 3-Pin RoHS Compliant Transition DC: 0532	Plastic TO-220 3-Pin RoHS Compliant Transition DC: 0543	Plastic TO-263 3-Pin RoHS Compliant Transition DC: 0535
0 to 125	2.0%	1.5V	LX8385-xxCDT	LX8385-xxCP	LX8385-xxCDD
	2.0%	1.3V	LX8385A-xxCDT	LX8385A-xxCP	LX8385A-xxCDD
	1.0%	1.3V	LX8385B-xxCDT	LX8385B-xxCP	LX8385B-xxCDD
-25 to 125	2.0%	1.5V	LX8385-xxIDT	LX8385-xxIP	LX8385-xxIDD

Note: Available in Tape & Reel. Append the letters "TR" to the part number. (i.e. LX8385-xxCP-TR)

ABSOLUTE MAXIMUM RATINGS (NOTE 1)

Power Dissipation.....	Internally Limited
Input Voltage.....	10V
Input to Output Voltage Differential.....	10V
Operating Junction Temperature.....	150°C
Storage Temperature Range.....	-65°C to 150 °C
Peak Package Solder Reflow Temp (40 seconds max. exposure).....	260°C (+0, -5)

Note 1: Exceeding these ratings could cause damage to the device. All voltages are with respect to Ground. Currents are positive into, negative out of specified terminal.

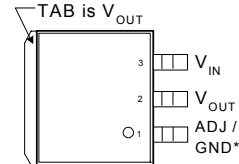
PACKAGE PIN OUT

DD PACKAGE (3-PIN)
(Top View)

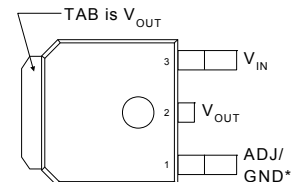

DT PACKAGE (3-PIN)
(Top View)

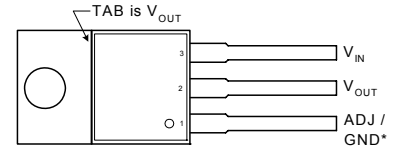

P PACKAGE (3-PIN)
(Top View)

*Pin 1 is GND for fixed voltage versions

RoHS 100% Matte Tin Lead Finish

THERMAL DATA
DD Plastic TO-263 3-Pin

THERMAL RESISTANCE-JUNCTION TO AMBIENT, θ_{JA}	60°C/W
THERMAL RESISTANCE-JUNCTION TO TAB, θ_{JT}	2.7°C/W

P Plastic TO-220 3-Pin

THERMAL RESISTANCE-JUNCTION TO AMBIENT, θ_{JA}	60°C/W
THERMAL RESISTANCE-JUNCTION TO TAB, θ_{JT}	2.7°C/W

DT Plastic TO-252 3-Pin

THERMAL RESISTANCE-JUNCTION TO AMBIENT, θ_{JA}	60°C/W
THERMAL RESISTANCE-JUNCTION TO TAB, θ_{JT}	2.7°C/W

Junction Temperature Calculation: $T_J = T_A + (P_D \times \theta_{JT})$.

The θ_{JA} & θ_{JT} numbers are guidelines for the thermal performance of the device/pc-board system. All of the above assume no ambient airflow.

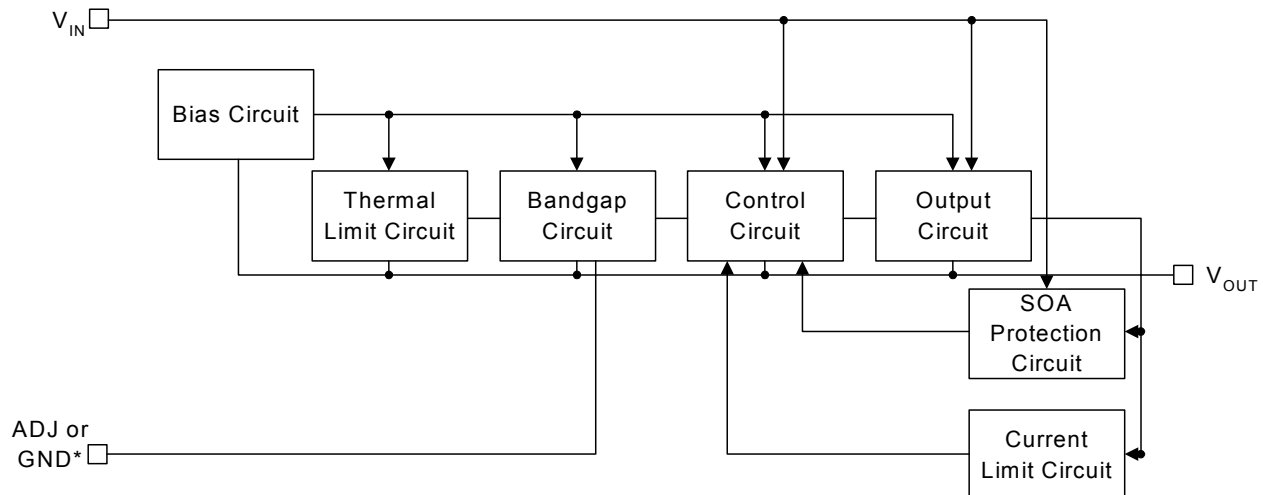
BLOCK DIAGRAM

*Pin 1 is GND for fixed voltage versions

ELECTRICAL CHARACTERISTICS

Unless otherwise specified, the following specifications apply over the operating ambient temperature for the LX8385x-xxC with $0^{\circ}\text{C} \leq T_A \leq 125^{\circ}\text{C}$ and the LX8385-xxI with $-25^{\circ}\text{C} \leq T_A \leq 125^{\circ}\text{C}$ except where otherwise noted. Test conditions: $V_{\text{IN}} - V_{\text{OUT}} = 3\text{V}$; $I_{\text{OUT}} = 3\text{A}$. Low duty cycle pulse testing techniques are used which maintains junction and case temperatures equal to the ambient temperature.

Parameter	Symbol	Test Conditions	LX8385x-xx			Units	
			Min	Typ	Max		
LX8385-00 / 8385A-00 / 8385B-00 (ADJUSTABLE)							
Reference Voltage (Note 4)	LX8385/85A-00 LX8385B-00	V_{REF}	$I_{\text{OUT}} = 10\text{mA}, T_A = 25^{\circ}\text{C}$	1.238	1.250	1.262	V
			$10\text{mA} \leq I_{\text{OUT}} \leq 3\text{A}, 1.5\text{V} \leq (V_{\text{IN}} - V_{\text{OUT}}), V_{\text{IN}} \leq 10\text{V}, P \leq P_{\text{MAX}}$	1.225	1.250	1.270	V
			$I_{\text{OUT}} = 10\text{mA}, T_A = 25^{\circ}\text{C}$	1.240	1.250	1.260	V
			$10\text{mA} \leq I_{\text{OUT}} \leq 3\text{A}, 1.5\text{V} \leq (V_{\text{IN}} - V_{\text{OUT}}), V_{\text{IN}} \leq 10\text{V}, P \leq P_{\text{MAX}}$	1.238	1.250	1.262	V
Line Regulation (Note 2)		$\Delta V_{\text{REF}}(V_{\text{IN}})$	$1.5\text{V} \leq (V_{\text{IN}} - V_{\text{OUT}}), V_{\text{IN}} \leq 7\text{V}, I_{\text{OUT}} = 10\text{mA}$		0.015	0.2	%
Load Regulation (Note 2)		$\Delta V_{\text{REF}}(I_{\text{OUT}})$	$V_{\text{OUT}} \geq V_{\text{REF}}, V_{\text{IN}} - V_{\text{OUT}} = 3\text{V}, 10\text{mA} \leq I_{\text{OUT}} \leq 3\text{A}$		0.15	0.5	%
Thermal Regulation		$\Delta V_{\text{OUT}}(P_{\text{wr}})$	$T_A = 25^{\circ}\text{C}, 20\text{ms pulse}$		0.01	0.04	% / W
Ripple Rejection (Note 3)			$V_{\text{OUT}} = 5\text{V}, f = 120\text{Hz}, C_{\text{OUT}} = 100\mu\text{F Tantalum}, V_{\text{IN}} = 6.5\text{V}, C_{\text{ADJ}} = 10\mu\text{F}, I_{\text{OUT}} = 3\text{A}$	65	83		dB
Adjust Pin Current		I_{ADJ}			55	100	μA
Adjust Pin Current Change (Note 4)		ΔI_{ADJ}	$10\text{mA} \leq I_{\text{OUT}} \leq I_{\text{OUT(MAX)}}, 1.5\text{V} \leq (V_{\text{IN}} - V_{\text{OUT}}), V_{\text{IN}} \leq 10\text{V}$		0.2	5	μA
Dropout Voltage	LX8385-00 LX8385A/85B-00	ΔV	$\Delta V_{\text{REF}} = 1\%, I_{\text{OUT}} = 3\text{A}$		1.2	1.5	V
			$\Delta V_{\text{REF}} = 1\%, I_{\text{OUT}} = 3\text{A}$		1.1	1.3	V
Minimum Load Current		$I_{\text{OUT(MIN)}}$	$V_{\text{IN}} \leq 10\text{V}$		2	10	mA
Maximum Output Current		$I_{\text{OUT(MAX)}}$	$(V_{\text{IN}} - V_{\text{OUT}}) \leq 7\text{V}, V_{\text{IN}} \leq 10\text{V}$	3	3.5		A
Long Term Stability (Note 3)		$\Delta V_{\text{OUT}}(t)$	$T_A = 125^{\circ}\text{C}, 1000 \text{ hours}$		0.3	1	%
Temperature Stability (Note 3)		$\Delta V_{\text{OUT}}(T)$			0.25		%
RMS Output Noise (% of V_{OUT}) (Note 3)		$\Delta V_{\text{OUT(RMS)}}$	$T_A = 25^{\circ}\text{C}, 10\text{Hz} \leq f \leq 10\text{kHz}$		0.003		%
LX8385-33/ 8385A-33/ 8385B-33 (3.3V FIXED)							
Output Voltage (Note 4)	LX8385/85A-33 LX8385B-33	V_{OUT}	$V_{\text{IN}} = 5\text{V}, I_{\text{OUT}} = 0\text{mA}, T_A = 25^{\circ}\text{C}$	3.267	3.3	3.333	V
			$4.75\text{V} \leq V_{\text{IN}} \leq 10\text{V}, 0\text{mA} \leq I_{\text{OUT}} \leq 3\text{A}, P \leq P_{\text{MAX}}$	3.235	3.3	3.365	V
			$V_{\text{IN}} = 5\text{V}, I_{\text{OUT}} = 0\text{mA}, T_A = 25^{\circ}\text{C}$	3.274	3.3	3.326	V
			$4.75\text{V} \leq V_{\text{IN}} \leq 10\text{V}, 0\text{A} \leq I_{\text{OUT}} \leq 3\text{A}, P \leq P_{\text{MAX}}$	3.267	3.3	3.333	V
Line Regulation (note 2)		$\Delta V_{\text{OUT}}(V_{\text{IN}})$	$4.75\text{V} \leq V_{\text{IN}} \leq 7\text{V}$		1	6	mV
			$4.75\text{V} \leq V_{\text{IN}} \leq 10\text{V}$		2	10	mV
Load Regulation (note 2)		$\Delta V_{\text{OUT}}(I_{\text{OUT}})$	$V_{\text{IN}} = 5\text{V}, 0\text{mA} \leq I_{\text{OUT}} \leq I_{\text{OUT(MAX)}}$		5	15	mV
Thermal Regulation		$\Delta V_{\text{OUT}}(P_{\text{wr}})$	$T_A = 25^{\circ}\text{C}, 20\text{ms pulse}$		0.01	0.02	% / W
Ripple Rejection (note 3)			$C_{\text{OUT}} = 100\mu\text{F (Tantalum)}, I_{\text{OUT}} = 3\text{A}$	60	83		dB
Quiescent Current		I_{Q}	$0\text{mA} \leq I_{\text{OUT}} \leq I_{\text{OUT(MAX)}}, 4.75\text{V} \leq V \leq 10\text{V}$		4	10	mA
Dropout Voltage	LX8385-33 LX8385A/85B-33	ΔV	$\Delta V_{\text{OUT}} = 1\%, I_{\text{OUT}} \leq I_{\text{OUT(MAX)}}$		1.2	1.5	V
			$\Delta V_{\text{OUT}} = 1\%, I_{\text{OUT}} \leq I_{\text{OUT(MAX)}}$		1.1	1.3	V

ELECTRICAL CHARACTERISTICS (CONTINUED)

Unless otherwise specified, the following specifications apply over the operating ambient temperature for the LX8385x-xxC with $0^{\circ}\text{C} \leq T_A \leq 125^{\circ}\text{C}$ and the LX8385-xxI with $-25^{\circ}\text{C} \leq T_A \leq 125^{\circ}\text{C}$ except where otherwise noted. Test conditions: $V_{\text{IN}} - V_{\text{OUT}} = 3\text{V}$; $I_{\text{OUT}} = 3\text{A}$. Low duty cycle pulse testing techniques are used which maintains junction and case temperatures equal to the ambient temperature.

Parameter	Symbol	Test Conditions	LX8385x-xx			Units
			Min	Typ	Max	
LX8385-33 / 8385A-33 / 8385B- (3.3V FIXED)(CONTINUED)						
Maximum Output Current	$I_{\text{OUT(MAX)}}$	$V_{\text{IN}} \leq 7\text{V}$	3	3.5		A
Temperature Stability (Note 3)	$\Delta V_{\text{OUT(T)}}$			0.25		%
Long Term Stability (Note 3)	$\Delta V_{\text{OUT (t)}}$	$T_A = 125^{\circ}\text{C}$, 1000 hours		0.3	1	%
RMS Output Noise (% of V_{OUT}) (Note 3)	$V_{\text{OUT (RMS)}}$	$T_A = 25^{\circ}\text{C}$, $10\text{Hz} \leq f \leq 10\text{kHz}$		0.003		%
LX8385-05 / 8385A-05 / 8385B-05 (5.0V FIXED)						
Output Voltage (Note 4)	V_{OUT}	$V_{\text{IN}} = 7\text{V}$, $I_{\text{OUT}} = 0\text{mA}$, $T_A = 25^{\circ}\text{C}$	4.950	5.00	5.050	V
		$7\text{V} \leq V_{\text{IN}} \leq 10\text{V}$, $0\text{mA} \leq I_{\text{OUT}} \leq 3\text{A}$, $P \leq P_{\text{MAX}}$	4.900	5.00	5.100	V
		$V_{\text{IN}} = 7\text{V}$, $I_{\text{OUT}} = 0\text{mA}$, $T_A = 25^{\circ}\text{C}$	4.960	5.00	5.040	V
		$7\text{V} \leq V_{\text{IN}} \leq 10\text{V}$, $0\text{mA} \leq I_{\text{OUT}} \leq 3\text{A}$, $P \leq P_{\text{MAX}}$	4.950	5.00	5.050	V
Line Regulation (Note 2)	$\Delta V_{\text{OUT}(V_{\text{IN}})}$	$7\text{V} \leq V_{\text{IN}} \leq 10\text{V}$		2	10	mV
Load Regulation (Note 2)	$\frac{\Delta V_{\text{OUT}}}{(I_{\text{OUT}})}$	$V_{\text{IN}} = 7\text{V}$, $0\text{mA} \leq I_{\text{OUT}} \leq I_{\text{OUT(MAX)}}$		5	25	mV
Thermal Regulation	$\frac{\Delta V_{\text{OUT}}}{(P_{\text{WR}})}$	$T_A = 25^{\circ}\text{C}$, 20ms pulse		0.01	0.02	% / W
Ripple Rejection (Note 3)		$C_{\text{OUT}} = 100\mu\text{F}$ (Tantalum), $I_{\text{OUT}} = 3\text{A}$	60	83		dB
Quiescent Current	I_{Q}	$0\text{mA} \leq I_{\text{OUT}} \leq I_{\text{OUT(MAX)}}$, $4.75\text{V} \leq V_{\text{IN}} \leq 10\text{V}$		4	10	mA
Dropout Voltage LX8385-33 LX8385A/85B-33	ΔV	$\Delta V_{\text{OUT}} = 1\%$, $I_{\text{OUT}} \leq I_{\text{OUT(MAX)}}$		1.2	1.5	V
		$\Delta V_{\text{OUT}} = 1\%$, $I_{\text{OUT}} \leq I_{\text{OUT(MAX)}}$		1.1	1.3	V
Maximum Output Current	$I_{\text{OUT(MAX)}}$	$V_{\text{IN}} \leq 10\text{V}$	3	3.5		A
Temperature Stability (Note 3)	$\Delta V_{\text{OUT (T)}}$			0.25		%
Long Term Stability (Note 3)	$\Delta V_{\text{OUT (t)}}$	$T_A = 125^{\circ}\text{C}$, 1000 hours		0.3	1	%
RMS Output Noise (% of V_{OUT}) (Note 3)	$V_{\text{OUT (RMS)}}$	$T_A = 25^{\circ}\text{C}$, $10\text{Hz} \leq f \leq 10\text{kHz}$		0.003		%

Note 2 Regulation is measured at constant junction temperature, using pulse testing with a low duty cycle. Changes in output voltage due to heating effects are covered under the specification for thermal regulation.

Note 3 These parameters, although guaranteed are not tested in production.

Note 4 See Maximum Output Current Section

APPLICATION NOTES

The LX8385/85A/85B Series ICs are easy to use Low-Dropout (LDO) voltage regulators. They have all of the standard self-protection features expected of a voltage regulator: short circuit protection, safe operating area protection and automatic thermal shutdown if the device temperature rises above approximately 165°C.

Use of an output capacitor is **REQUIRED** with the LX8385/85A/85B series. Please see the table below for recommended minimum capacitor values.

These regulators offer a more tightly controlled reference voltage tolerance and superior reference stability when measured against the older pin-compatible regulator types that they replace.

STABILITY

The output capacitor is part of the regulator's frequency compensation system. Many types of capacitors are available, with different capacitance value tolerances, capacitance temperature coefficients, and equivalent series impedances. For all operating conditions, connection of a 220µF aluminum electrolytic capacitor or a 47µF (<400mΩ ESR) solid tantalum capacitor between the output terminal and ground will guarantee stable operation.

If a bypass capacitor is connected between the output voltage adjust (ADJ) pin and ground, ripple rejection will be improved (please see the section entitled "RIPPLE REJECTION"). When ADJ pin bypassing is used, the required output capacitor value increases. Output capacitor values of 220µF (aluminum) or 47µF (tantalum) provide for all cases of bypassing the ADJ pin. If an ADJ pin bypass capacitor is not used, smaller output capacitor values are adequate. The table below shows recommended minimum capacitance values for operation.

Minimum Capacitor Values

INPUT	OUTPUT	ADJ
10µF	15µF Tantalum, 100µF Aluminum	None
10µF	47µF Tantalum, 220µF Aluminum	15µF

To ensure good transient response from the power supply system under rapidly changing current load conditions, designers generally use several output capacitors connected in parallel. Such an arrangement serves to minimize the effects of the parasitic resistance (ESR) and inductance (ESL) that are present in all capacitors. Cost-effective solutions that sufficiently limit ESR and ESL effects generally result in total capacitance values in the range of hundreds to thousands of microfarads, which is more than adequate to meet regulator output capacitor specifications. Output capacitance values may be increased without limit.

The circuit shown in Figure 1 can be used to observe the transient response characteristics of the regulator in a power system under changing loads. The effects of different capacitor types and values on transient response parameters, such as overshoot and under-shoot, can be compared quickly in order to develop an optimum solution.

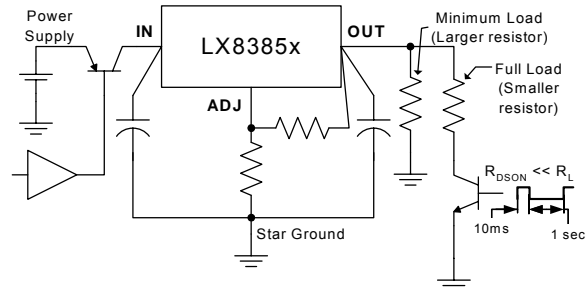

FIGURE 1 - DYNAMIC INPUT AND OUTPUT TEST

OVERLOAD RECOVERY

Like almost all IC power regulators, the LX8385/85A/85B regulators are equipped with Safe Operating Area (SOA) protection. The SOA circuit limits the regulator's maximum output current to progressively lower values as the input-to-output voltage difference increases. By limiting the maximum output current, the SOA circuit keeps the amount of power that is dissipated in the regulator itself within safe limits for all values of input-to-output voltage within the operating range of the regulator. The LX8385/85A/85B SOA protection system is designed to be able to supply some output current for all values of input-to-output voltage, up to the device breakdown voltage.

Under some conditions, a correctly operating SOA circuit may prevent a power supply system from returning to regulated operation after removal of an intermittent short circuit at the output of the regulator. This is a normal mode of operation, which can be seen, in most similar products, including older devices such as 7800 series regulators. It is most likely to occur when the power system input voltage is relatively high and the load impedance is relatively low.

When the power system is started "cold", both the input and output voltages are very close to zero. The output voltage closely follows the rising input voltage, and the input-to-output voltage difference is small. The SOA circuit therefore permits the regulator to supply large amounts of current as needed to develop the designed voltage level at the regulator output.

Now consider the case where the regulator is supplying regulated voltage to a resistive load under steady state conditions. A moderate input-to-output voltage appears across the regulator but the voltage difference is small enough that the SOA circuitry allows sufficient current to flow through the regulator to develop the designed output voltage across the load resistance. If the output resistor is short-circuited to ground, the input-to-output voltage difference across the regulator suddenly becomes larger by the amount of voltage that had appeared across the load resistor. The SOA circuit reads the increased input-to-output voltage, and cuts back the amount of current that it will permit the regulator to supply to its output terminal. When the short circuit across the output resistor is removed, all the regulator output current will again flow through the output resistor. The maximum current that the regulator can supply to the resistor will be limited by the SOA circuit, based on the large input-to-output

APPLICATION NOTES (CONTINUED)
OVERLOAD RECOVERY (continued)

voltage across the regulator at the time the short circuit is removed from the output. If this limited current is not sufficient to develop the designed voltage across the output resistor, the voltage will stabilize at some lower value, and will never reach the designed value. Under these circumstances, it may be necessary to cycle the input voltage down to zero in order to make the regulator output voltage return to regulation.

RIPPLE REJECTION

Ripple rejection can be improved by connecting a capacitor between the ADJ pin and ground. The value of the capacitor should be chosen so that the impedance of the capacitor is equal in magnitude to the resistance of R_1 at the ripple frequency. The capacitor value can be determined by using this equation:

$$C = \frac{1}{(6.28 \times F_R \times R_1)}$$

where: C \equiv the value of the capacitor in Farads; select an equal or larger standard value.

F_R \equiv the ripple frequency in Hz

R_1 \equiv the value of resistor R_1 in ohms

At a Ripple frequency of 120Hz, with $R_1 = 100\Omega$:

$$C = \frac{1}{(6.28 \times 120\text{Hz} \times 100\Omega)} = 13.3\mu\text{F}$$

The closest equal or larger standard value should be used, in this case, 15 μF . When an ADJ pin bypass capacitor is used, output ripple amplitude will be essentially independent of the output voltage. If an ADJ pin bypass capacitor is not used, output ripple will be proportional to the ratio of the output voltage to the reference voltage:

$$M = \frac{V_{OUT}}{V_{REF}}$$

where: M \equiv a multiplier for the ripple seen when the ADJ pin is optimally bypassed.

$$V_{REF} = 1.25\text{V}$$

For example, if $V_{OUT} = 2.5\text{V}$ the output ripple will be:

$$M = \frac{2.5\text{V}}{1.25\text{V}} = 2$$

Output ripple will be twice as bad as it would be if the ADJ pin were to be bypassed to ground with a properly selected capacitor.

OUTPUT VOLTAGE

The LX8385/85A/85B ICs develop a 1.25V reference voltage between the output and the adjust terminal (See Figure 2). By placing a resistor, R_1 , between these two terminals, a constant current is caused to flow through R_1 and down through R_2 to set the overall output voltage. Normally this current is the specified minimum load current of 10mA. Because I_{ADJ} is very small and constant when compared with the current through R_1 , it represents a small error and can usually be ignored.

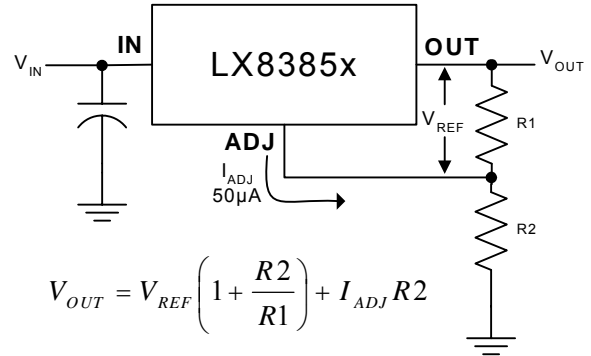
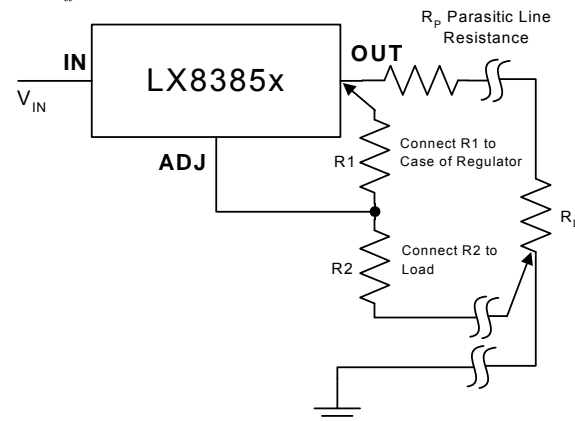

FIGURE 2 - BASIC ADJUSTABLE REGULATOR
LOAD REGULATION

Because the LX8385/85A/85B regulators are three-terminal devices, it is not possible to provide true remote load sensing. Load regulation will be limited by the resistance of the wire connecting the regulator to the load. The data sheet specification for load regulation is measured at the bottom of the package. Negative side sensing is a true Kelvin connection, with the bottom of the output divider returned to the negative side of the load. Although it may not be immediately obvious, best load regulation is obtained when the top of the resistor divider, (R_1), is connected *directly* to the case of the regulator, *not to the load*. This is illustrated in Figure 3. If R_1 were connected to the load, the effective resistance between the regulator and the load would be:

$$R_{P_{eff}} = R_P \times \left(\frac{R_2 + R_1}{R_1} \right)$$

where: R_P \equiv Actual parasitic line resistance.

When the circuit is connected as shown in Figure 3, the parasitic resistance appears as its actual value, rather than the higher $R_{P_{eff}}$.

FIGURE 3 - CONNECTIONS FOR BEST LOAD REGULATION

APPLICATION NOTES (CONTINUED)
LOAD REGULATION (continued)

Even when the circuit is configured optimally, parasitic resistance can be a significant source of error. A 20 mil. wide PC trace built from 1 oz. copper-clad circuit board material has a parasitic resistance of about 25 milliohms per inch of its length at room temperature. If a 3-terminal regulator used to supply 2.50 volts is connected by 2 inches of this trace to a load which draws 1.5 amps of current, a 75 millivolt drop will appear between the regulator and the load. Even when the regulator output voltage is precisely 2.50 volts, the load will only see 2.43 volts, which is a 3% error. It is important to keep the connection between the regulator output pin and the load as short as possible, and to use wide traces or heavy-gauge wire.

The minimum specified output capacitance for the regulator should be located near the regulator package. If several capacitors are used in parallel to construct the power system output capacitance, any capacitors beyond the minimum needed to meet the specified requirements of the regulator should be located near the sections of the load that require rapidly-changing amounts of current. Placing capacitors near the sources of load transients will help ensure that power system transient response is not impaired by the effects of trace impedance.

To maintain good load regulation, wide traces should be used on the input side of the regulator, especially between the input capacitors and the regulator. Input capacitor ESR must be small enough that the voltage at the input pin does not drop below $V_{IN(MIN)}$ during transients.

$$V_{IN(MIN)} = V_{OUT} + V_{DROPOUT(MAX)}$$

- where: $V_{IN(MIN)}$ \equiv the lowest allowable instantaneous voltage at the input pin.
 V_{OUT} \equiv the designed output voltage for the power supply system.
 $V_{DROPOUT(MAX)}$ \equiv the specified dropout voltage for the installed regulator.

THERMAL CONSIDERATIONS

The LX8385/85A/85B regulators have internal power and thermal limiting circuitry designed to protect each device under overload conditions. For continuous normal load conditions, however, maximum junction temperature ratings must not be exceeded. It is important to give careful consideration to all sources of thermal resistance from junction to ambient. This includes junction to case, case to heat sink interface, and heat sink thermal resistance itself.

Junction-to-case thermal resistance is specified from the IC junction to the back surface of the case directly opposite the die. This is the lowest resistance path for heat flow. Proper mounting is required to ensure the best possible thermal flow from this area of the package to the heat sink. Thermal compound at the case to heat sink interface is strongly recommended. If the case of the device must be electrically isolated, a thermally conductive spacer can be used, as long as its added contribution to thermal resistance is considered. Note that the case of all devices in this series is electrically connected to the output.

Example

Given: $V_{IN} = 5V$
 $V_{OUT} = 2.5V$
 $I_{OUT} = 1.5A$
 $T_A = 50^\circ C$
 $R_{\theta JT} = 2.7^\circ C/W$ for TO-220

Find: Proper Heat Sink to keep IC's junction temperature below $125^\circ C$.**

Solution: The junction temperature is:

$$T_J = P_D (R_{\theta JT} + R_{\theta CS} + R_{\theta SA}) + T_A$$

- where: P_D \equiv Dissipated power.
 $R_{\theta JT}$ \equiv Thermal resistance from the junction to the mounting tab of the package.
 $R_{\theta CS}$ \equiv Thermal resistance through the interface between the IC and the surface on which it is mounted. ($1.0^\circ C/W$ at 6 in-lbs mounting screw torque).
 $R_{\theta SA}$ \equiv Thermal resistance from the mounting surface to ambient (thermal resistance of the heat sink).
 T_S \equiv Heat Sink Temperature.

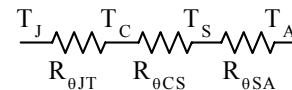

First, find the maximum allowable thermal resistance of the heat sink:

$$R_{\theta SA} = \frac{T_J - T_A}{P_D} - (R_{\theta JT} + R_{\theta CS})$$

$$P_D = (V_{IN(MAX)} - V_{OUT}) I_{OUT} = (5.0V - 2.5V) \times 1.5A$$

$$P_D = 3.75W$$

$$R_{\theta SA} = \frac{125^\circ C - 50^\circ C}{(5.0V - 2.5V) * 1.5A} - (2.7^\circ C/W + 1.0^\circ C/W)$$

$$R_{\theta SA} = 16.3^\circ C/W$$

Next, select a suitable heat sink. The selected heat sink must have $R_{\theta SA} < 16.3^\circ C/W$. Thermalloy heatsink 6230B has $R_{\theta SA} = 12^\circ C/W$.

Finally, verify that junction temperature remains within specification using the selected heat sink:

$$T_J = 3.75W(2.7^\circ C/W + 1.0^\circ C/W + 12.0^\circ C/W) + 50^\circ C$$

$$T_J = 109^\circ C$$

** Although the device can operate up to $150^\circ C$ junction, it is recommended for long term reliability to keep the junction temperature below $125^\circ C$ whenever possible.

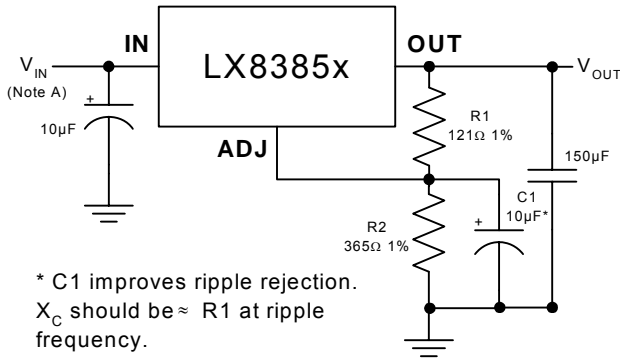
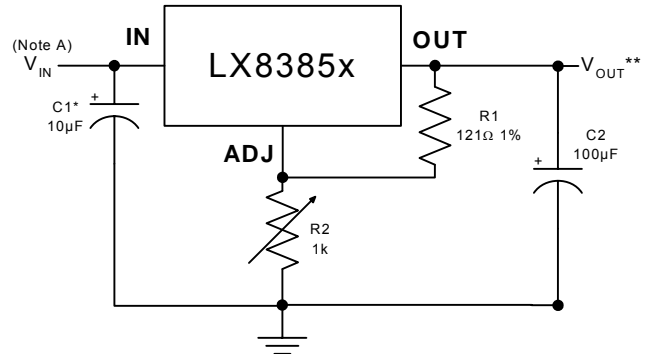
TYPICAL APPLICATIONS

FIGURE 4 - IMPROVING RIPPLE REJECTION

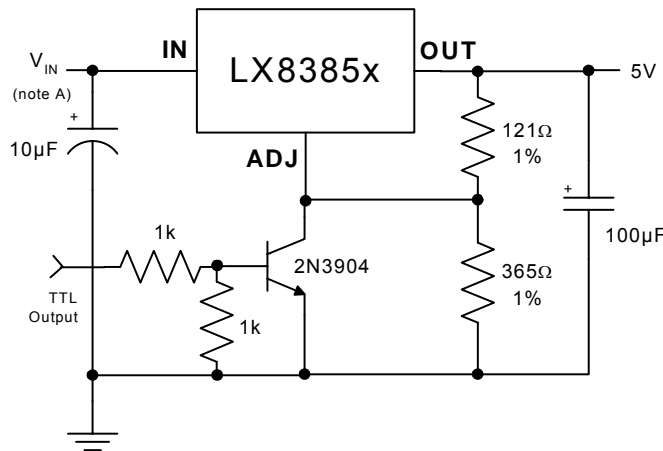
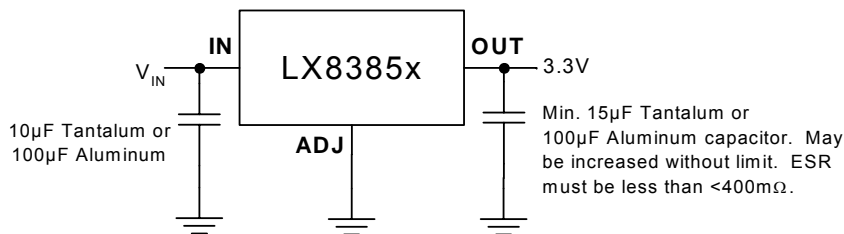
$$**V_{OUT} = 1.25V \left(1 + \frac{R2}{R1} \right)$$

FIGURE 5 - 1.2V - 8V ADJUSTABLE REGULATOR

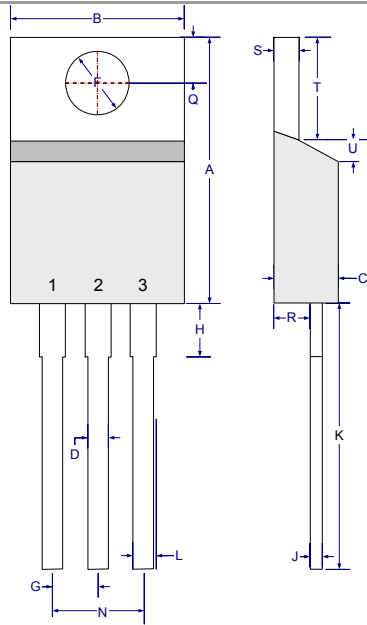
FIGURE 6 - 5V REGULATOR WITH SHUTDOWN

FIGURE 7 - FIXED 3.3V OUTPUT REGULATOR

Note A: $V_{IN(MIN)} = (Intended V_{OUT}) + V_{DROPOUT(MAX)}$

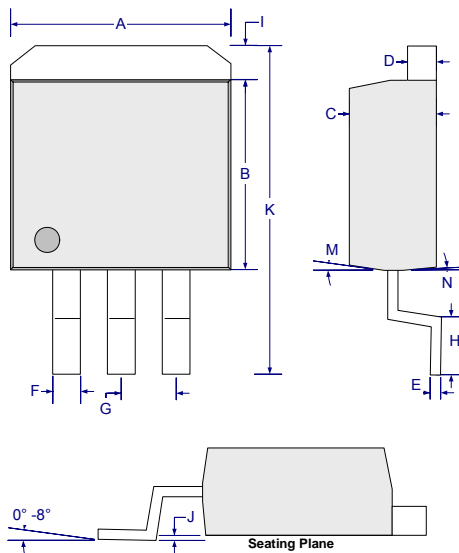
PACKAGE DIMENSIONS
P 3-Pin Plastic TO-220

Dim	MILLIMETERS		INCHES	
	MIN	MAX	MIN	MAX
A	14.22	15.88	0.560	0.625
B	9.65	10.67	0.380	0.420
C	3.56	4.83	0.140	0.190
D	0.51	1.14	0.020	0.045
F	3.53	4.09	0.139	0.161
G	2.54 BSC		0.100 BSC	
H		6.35		0.250
J	0.30	1.14	0.012	0.045
K	12.70	14.73	0.500	0.580
L	1.14	1.27	0.045	0.050
N	5.08 TYP		0.200 TYP	
Q	2.54	3.05	0.100	0.120
R	2.03	2.92	0.080	0.115
S	1.14	1.40	0.045	0.055
T	5.84	6.86	0.230	0.270
U	0.508	1.14	0.020	0.045

DD 3-Pin Plastic TO-263

Dim	MILLIMETERS		INCHES	
	MIN	MAX	MIN	MAX
A	10.03	10.67	0.395	0.420
B	8.51	9.17	0.335	0.361
C	4.19	4.59	0.165	0.181
D	1.14	1.40	0.045	0.055
E	0.330	0.51	0.013	0.020
F	1.19	1.34	0.047	0.053
G	2.41	2.66	0.095	0.104
H	2.29	2.79	0.090	0.110
I	-	1.65	-	0.065
J	0	0.25	0	0.010
K	14.60	15.87	0.575	0.625
M	7°		7°	
N	3°		3°	

Note: Dimensions do not include mold flash or protrusions; these shall not exceed 0.155mm(.006") on any side. Lead dimension shall not include solder coverage.

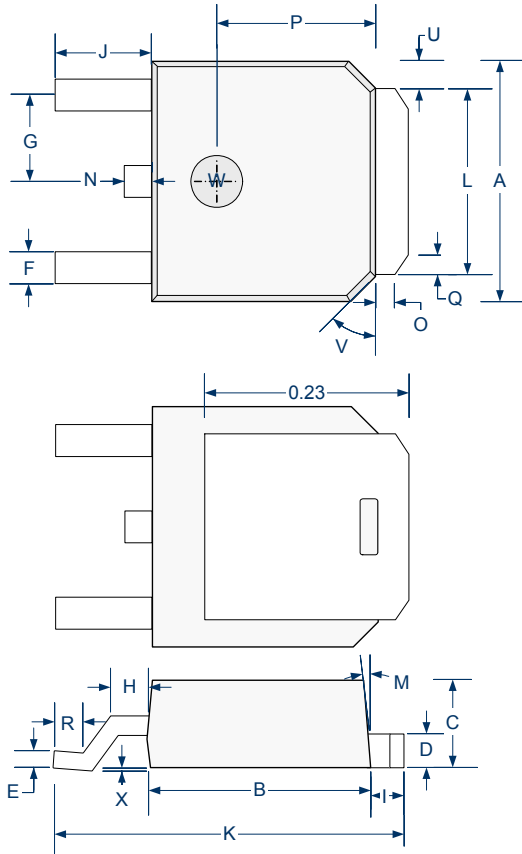
PACKAGE DIMENSIONS
DT 3-Pin Plastic TO-252

Dim	MILLIMETERS		INCHES	
	MIN	MAX	MIN	MAX
A	6.47	6.73	0.255	0.265
B	5.97	6.23	0.235	0.245
C	2.16	2.42	0.085	0.095
D	0.68	0.94	0.027	0.037
E	0.38	0.64	0.015	0.025
F	0.63	0.89	0.025	0.035
G	2.16	2.42	0.085	0.095
H	0.84	1.10	0.033	0.043
I	0.89	1.15	0.035	0.045
J	2.44	2.70	0.096	0.106
K	9.55	9.81	0.376	0.386
L	5.20	5.46	0.205	0.215
M	7.0°		7.0°	
N	0.51	0.77	0.020	0.030
O	0.51	0.77	0.020	0.030
P	4.19	4.45	0.165	0.175
Q	0.76	1.02	0.030	0.040
R	0.48	0.74	0.019	0.029
U	0.51	0.77	0.020	0.030
V	45°		45°	
W	1.44	1.70	0.057	0.067
X	0	0.10	0	0.004



LX8385x-xx

3A Low Dropout Positive Regulators

PRODUCTION DATA SHEET

NOTES

PRODUCTION DATA – Information contained in this document is proprietary to Microsemi and is current as of publication date. This document may not be modified in any way without the express written consent of Microsemi. Product processing does not necessarily include testing of all parameters. Microsemi reserves the right to change the configuration and performance of the product and to discontinue product at any time.